



JOIST LED

felt ceiling baffle





HOW TO SPECIFY

Joist just got an upgrade!
Introducing the Joist LED Ceiling Baffle – state-of-the-art lighting solution that combines superior LED lighting technology with a unique baffle design. Optimal illumination and acoustic performance in one integrated solution.

01 SPECS

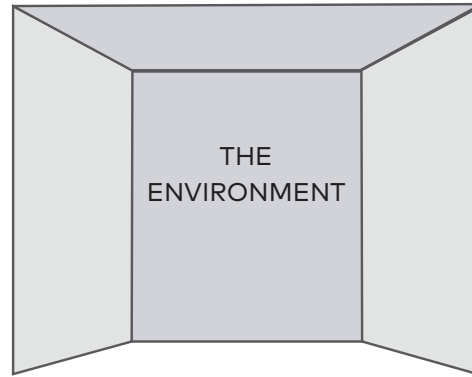

Tell us about your space, the design, and dimensions.

02 LIGHTING DIRECTION

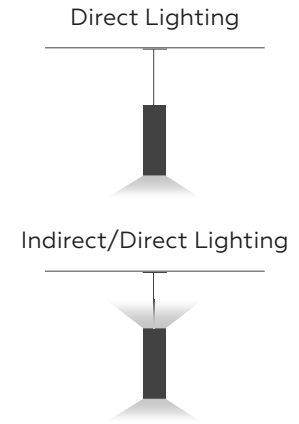

Does your project call for direct lighting, indirect lighting, or both?.

03 COLORS

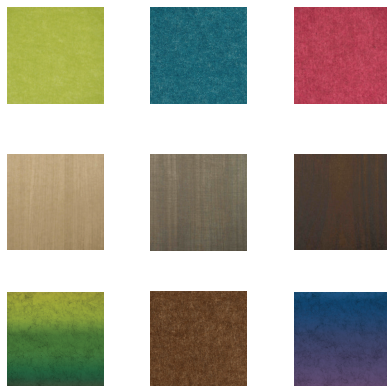

Standard. Woodgrains. Customs.
What's your color? (See page 6)

04 MAKE IT YOUR OWN!

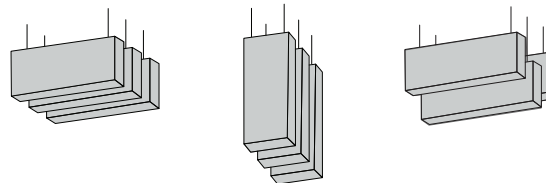

Spec your own configuration.
Customize orientation, spacing, etc.

SHADES by MPS™



Spec your own color, gradient, or woodgrain. (See page 6)



PRODUCT SPECIFICATIONS

STANDARD DIMENSIONS

- 26.53"L x 7-12"H x 2.77"W
- 49.27"L x 7-12"H x 2.77"W
- 73.27"L x 7-12"H x 2.77"W
- 95.20"L x 7-12"H x 2.77"W

FINAL ASSEMBLY

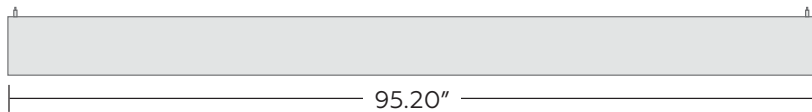
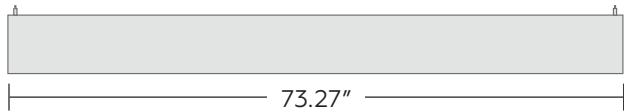
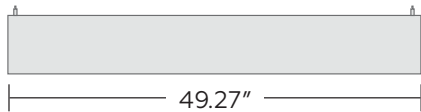
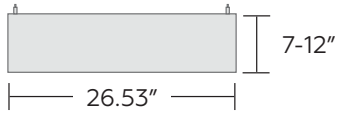

FIXTURE WITHOUT BAFFLES

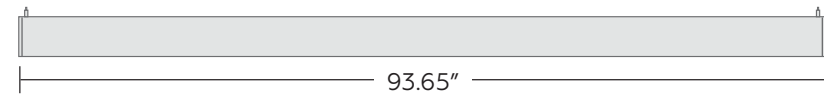
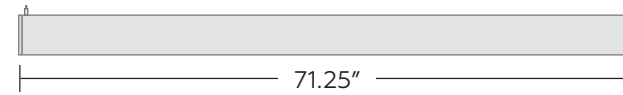
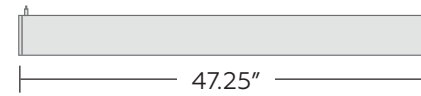
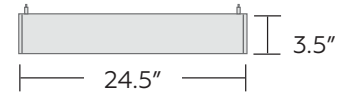
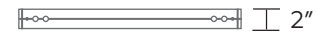



FIXTURE DETAILS

CROSS SECTION

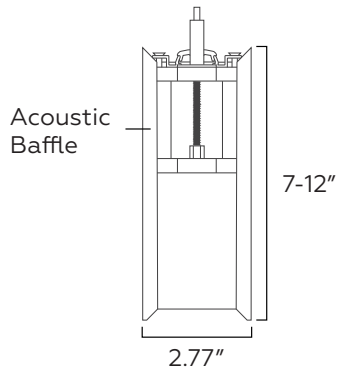

DIRECT/INDIRECT LIGHTING

Direct Lighting

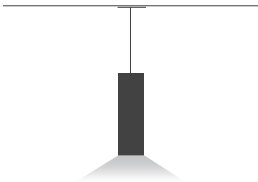

Indirect/Direct Lighting

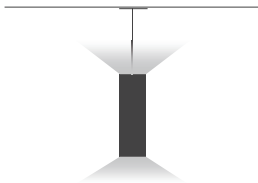

SAMPLE PART NUMBER: JOIST-LED-06-HD-35-UNV-JB-BLK-52-P12

ORDER LENGTH	DISTANCE BETWEEN CABLE MOUNTS	ACTUAL OVERALL LENGTH
2 FT	24.50	26.5
4 FT	47.25	49.25
6 FT	71.25	73.25
8 FT	93.65	95.65

DIRECT OUTPUT		CCT	VOLTAGE	MOUNTING		FIXTURE COLOR
VHD 1250 LM/FT	LD 500 LM/FT	30 3000K	UNV 120-277V	T11" Grid	HC Hard Ceiling	WH White
HD 1000 LM/FT	VLD 250 LM/FT	35 3500K	347 ² 347V	T9 9/16" Grid	JB Junction Box	BLK Black
MD 750 LM/FT	CD Custom	40 4000K		SC Screw Slot		S Silver
						GR Charcoal Grey

CRI	SUSPENSION		INTEGRATED CONTROLS	EMERGENCY
BLANK = 80 CRI	BLANK = 48" CABLE	CB144 144" Cables	OS Occupancy Sensor	EM ³ Emergency Battery
C90 90 CRI	CB96 96" Cables	BC Black Canopy & Cord	DOS Daylight Occupancy Sensor	

STANDARD COLORS				STANDARD WOODGRAINS	
24 Snow	22 Khaki	191 Stone	15 Evergreen	52 Ash	62 Italian Walnut
43 Ivory	39 Earth	192 Ocean	157 Midnight	66 Weathered Plywood	63 Main Street Elm
07 Sand	40 Coffee	92 Denim	09 Onyx	61 Fresh Plywood	50 Dark Walnut
03 Marble	13 Wine	18 Granite		54 Plywood	65 Vista Walnut
21 Cream	12 Avocado	33 Slate		64 Planche Oak	
14 Biscuit	93 Sage	04 Graphite		53 Honey	



FIXTURE DETAILS

LED LIGHT OVERVIEW

INDIRECT / DIRECT

ZONE	LUMENS	% FIXT
0-30	915	15%
0-40	1456	24%
0-60	2454	41%
0-90	3048	51%
90-180	2988	50%
0-180	6035	100%

DIRECT

ZONE	LUMENS	% FIXT
0-30	915	15%
0-40	1456	24%
0-60	2454	41%
0-90	3048	51%
90-180	2988	50%
0-180	6035	100%

	VHD 1200	HD 1000	MD 750	LD 500	VLD 250
W/FT	11.6	9.7	7.2	4.8	2.4
LM/FT	1194	1037	762	515	253
LM/W	102.6	106.9	105.5	107.2	104.3

BATWING UP / SYMMETRICAL DOWN

	VHU-VHD	VHU-HD	VHD-MD	VHU-LD	VHU-VLD
W/FT	19.5	17.6	15.1	12.7	10.3
LM/FT	2416.2	2259.0	1984.2	1736.4	1475.3
LM/W	123.9	128.6	131.5	137.2	143.4

	VLU-VHD	VLU-HD	VLU-MD	VLU-LD	VLU-VLD
W/FT	13.1	11.2	8.7	6.3	3.9
LM/FT	1433.5	1276.3	1001.6	753.7	492.6
LM/W	109.3	114.2	115.1	120.1	126.1

	LU-VHD	LU-HD	LU-MD	LU-LD	LU-VLD
W/FT	14.8	12.8	10.3	7.9	5.6
LM/FT	1692.3	1535.1	1260.4	1012.5	751.5
LM/W	114.6	119.7	121.8	127.8	135.4

	MU-VHD	MU-HD	MU-MD	MU-LD	MU-VLD
W/FT	16.3	14.4	11.9	9.5	7.1
LM/FT	1944.5	1787.3	1512.6	1264.7	1003.7
LM/W	119.1	124.3	127.1	133.4	141.2

	HU-VHD	HU-HD	HU-MD	HU-LD	HU-VLD
W/FT	18.2	16.3	13.8	11.4	9.0
LM/FT	2211.9	2054.7	1780	1532.1	1217.0
LM/W	121.5	126.3	129.1	134.8	141.3



TECHNICAL SPECIFICATIONS



Absorption

Standard: 1.4 NRC

Fire Rating

ASTM E84 Class A

Warranty

Acoustic Baffle - Two (2) Years

LED Fixture - Ten (10) Years

VOC

ASTM D5116 Compliant

Material

PET Felt: 100% polyester fiber

Maintenance

Vacuum clean to remove dust and debris

Sustainability

Declare.

MPS 9mm Acoustic Panels
MPS LLC

Final Assembly: Trenton, Texas, USA

Life Expectancy: 50 Year(s)

End of Life Options: Salvageable/Reusable in its Entirety, Take Back Program (Trenton, TX), Recyclable (100%)

Ingredients:

MPS 9mm PET: Polyethylene Terephthalate

Living Building Challenge Criteria: Compliant

I-13 Red List:

- LBC Red List Free % Disclosed: 100% at 100ppm
- LBC Red List Approved VOC Content: Not Applicable
- Declared

I-10 Interior Performance: CDPH Standard Method v1.2-2017

I-14 Responsible Sourcing: Not Applicable

MPS-0001
EXP. 01 NOV 2025
Original Issue Date: 2022

MANUFACTURER RESPONSIBLE FOR LABEL ACCURACY
INTERNATIONAL LIVING FUTURE INSTITUTE™ living-future.org/declare



OEKO-TEX®
CONFIDENCE IN TEXTILES
STANDARD 100





COLORS & WOODGRAINS

MPS offers a range of standard colors, woodgrains, and custom colors with SHADES.

STANDARD COLORS



WOODGRAINS



SHADES by MPS

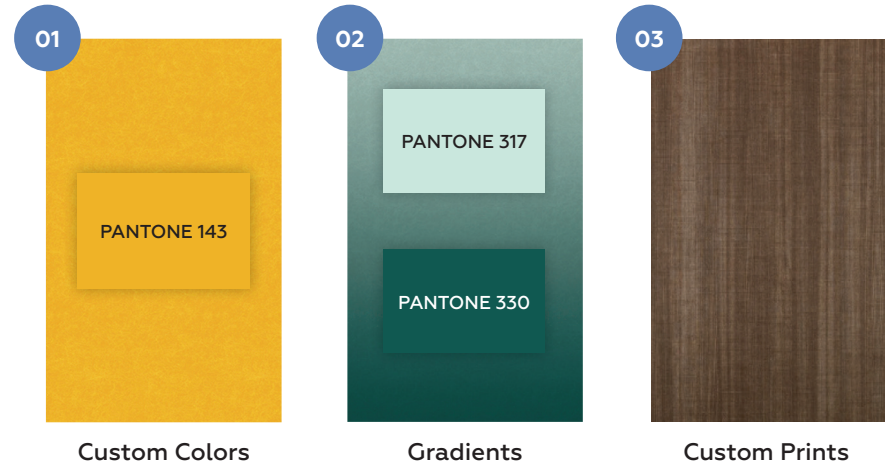

Your design world revolves around color, so don't be limited by standard colors and outdated palettes. SHADES offers Pantone options, full-color prints, and unique gradients. Flat or Heathered? Your choice.

*Some limitations apply. Consult your MPS acoustics expert to discuss your project.



PRODUCT INSTALLATION

CABLE MOUNTING "ON GRID" (T1, T9, & SC)

- Linear suspended Joist LED is intended for "On Grid" or "T-Bar Ceiling" cable mounting are to be installed with T1 (1" T-Grid), T9 (9/16" T-Grid), or SC (Screw Slot Grid) Feed and Hanger Kits. Feed and Hanger Kits are shipped in separate kitting boxes.

CABLE MOUNTING "OFF GRID" (HC & JB)

- Linear suspended Joist LED is intended for cable mounting are to be installed with HC (Hard Ceiling) or JB (Junction Box) Feed and Hanger Kits. Feed and Hanger Kits are shipped in separate kitting boxes.

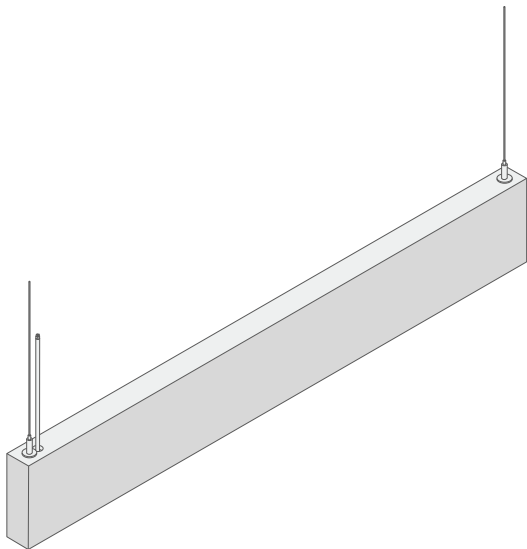

HANGING HARDWARE INSTALLATION

T1, T9, SC above grid install

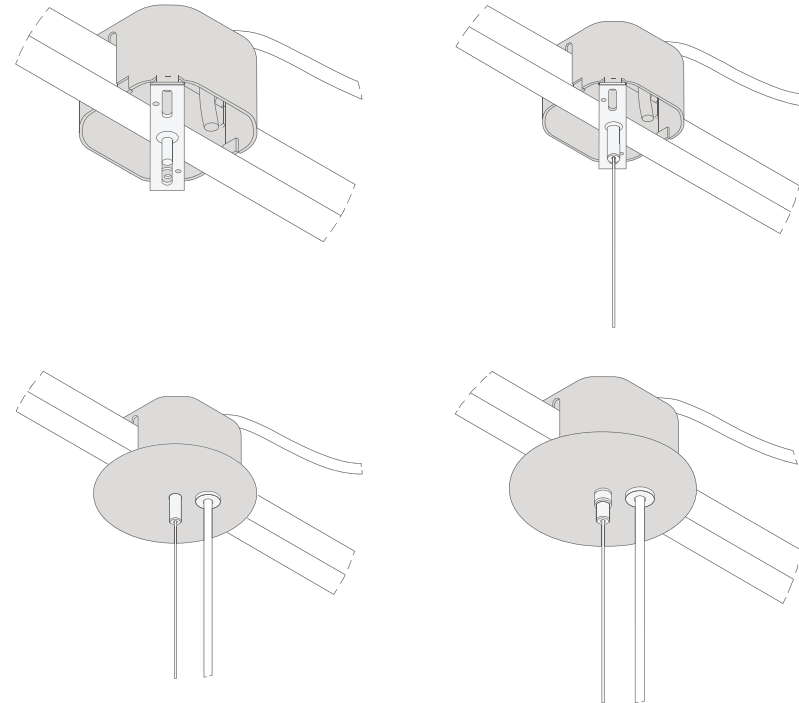



PRODUCT INSTALLATION

SUSPENDED BAFFLE INSTALLATION

Non-feed cable/canopy assembly

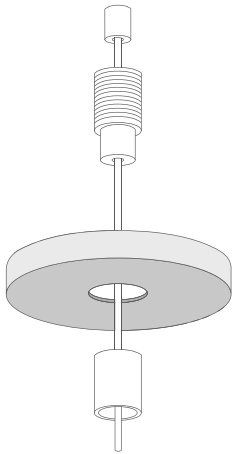
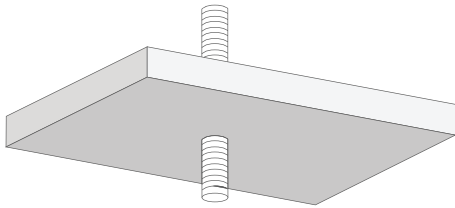

J-BOX

Cable fed through a junctionm box

