



## ENTWINE

felt ceiling baffle





# ENTWINE CEILING-MOUNTED BAFFLES

Welcome to the installation guide for Entwine, a beautiful acoustic ceiling aesthetic that adds dimension to any space. This guide will walk you through the easy-to-follow steps to securely mount Entwine using cable grippers, ensuring optimal acoustic performance and seamless integration into your space.

Installers should rely upon their own professional experience and understanding of their unique requirements to ensure a successful install.

**\*NOTE: Staggered seams are standard for baffle installation.**

## TOOLS REQUIRED



Cutting tool



Steel straightedge



Drill

## MOUNTING OPTIONS

Entwine can be mounted using cable grippers. Cable grippers are compatible with 15/16" t-grids.

## CABLE GRIPPER





## PRODUCT SPECIFICATIONS

### CONTINUOUS BAFFLE

Need Entwine to span a larger space?

Connect multiple baffles to make it look like one, long, continuous baffle.

### DOVETAIL

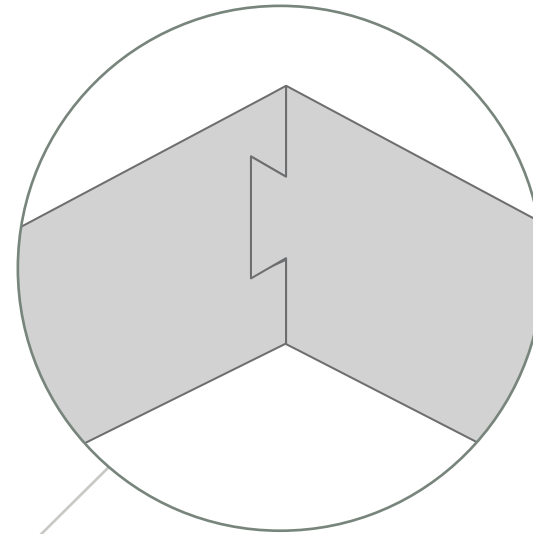

Dovetail connection  
for continuous runs

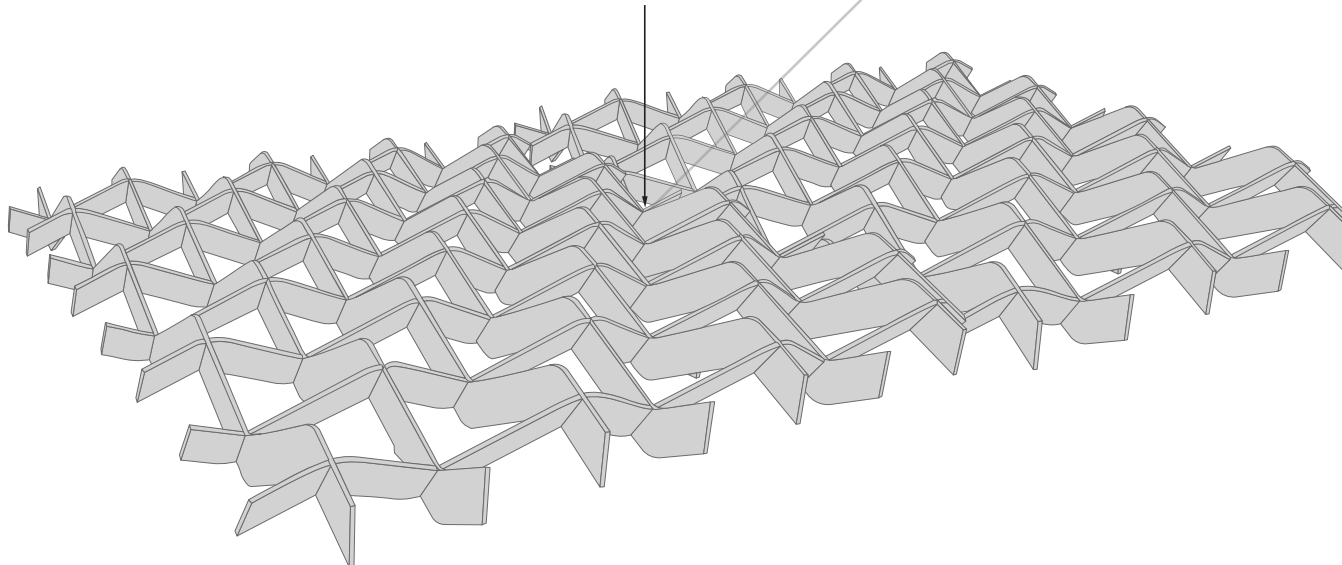



# INSTALLING ENTWINE

## MOUNTING WITH CABLE GRIPPERS

Entwine is intended to mount to any ceiling using cable grippers.

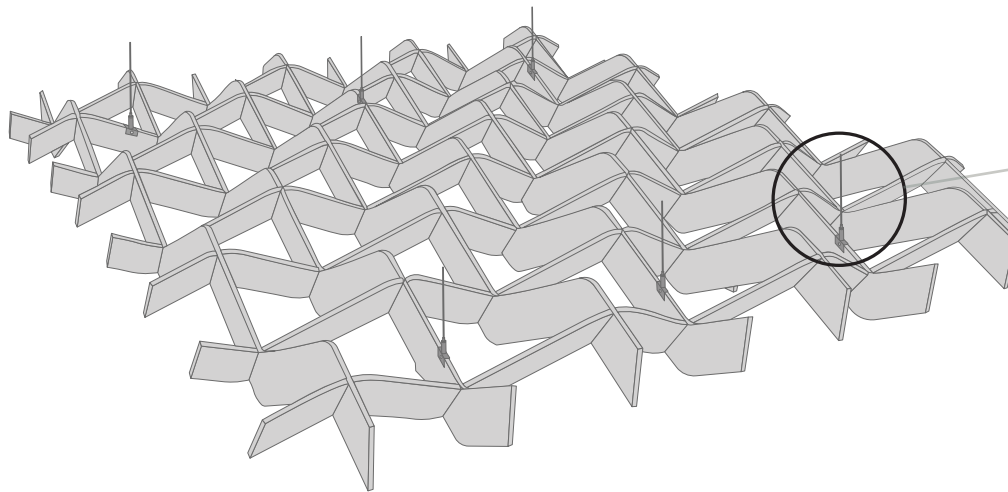

CABLE GRIPPER  
HARDWARE TO  
ATTACH BAFFLE  
TO CEILING

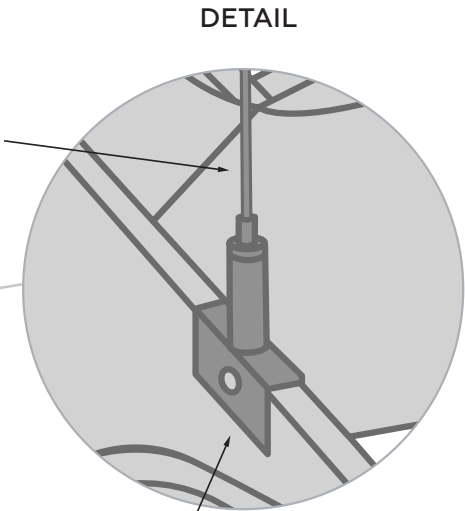

U-CHANNEL TO  
ATTACH CABLE  
TO BAFFLE

### Drop Ceiling

Compatible with 15/16" t-grids.

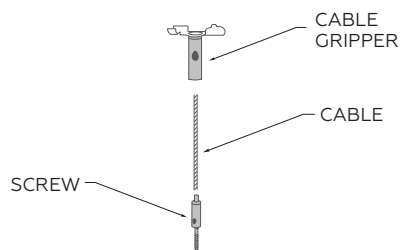
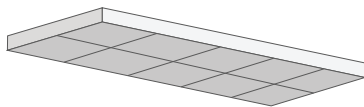

### Decorative Hard Ceiling

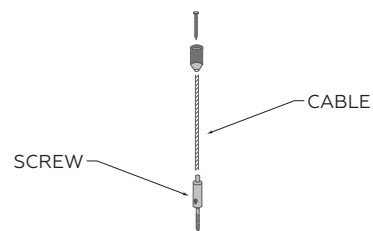
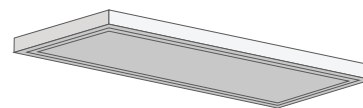

### Hard Ceiling

