



DECO

felt wall





# HOW TO SPECIFY

Re-think, re-design, reveal what a wall can be with Deco. The precise geometric pattern adds intrigue to any space, while also exposing a carefully curated secondary color. Reduce unwanted noise and echo with Deco acoustic felt walls.

Available in over 30 colorways.

## 01 SPECS

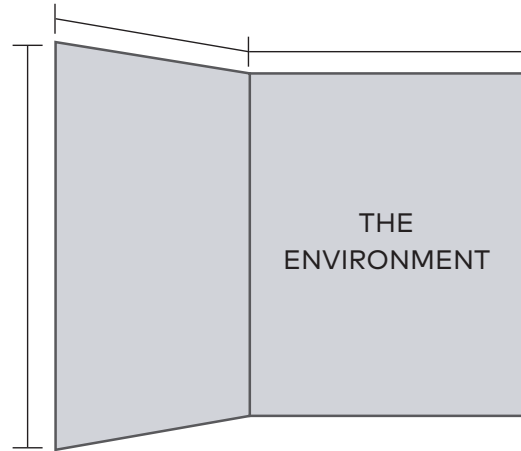

Tell us about your space, the design, and dimensions.

## 02 PATTERN SIZES

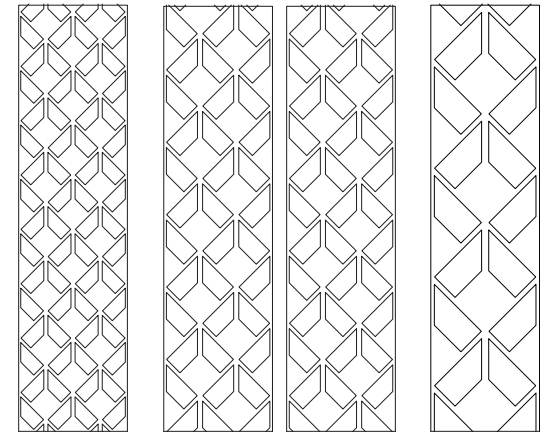

What size does your design call for? Deco is offered in four pattern sizes.

## 03 COLORWAYS

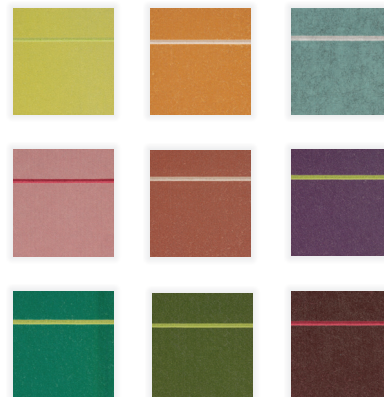

Over 30 standard colorways. What's your color? (See page 7)

## 04 MAKE IT YOUR OWN!

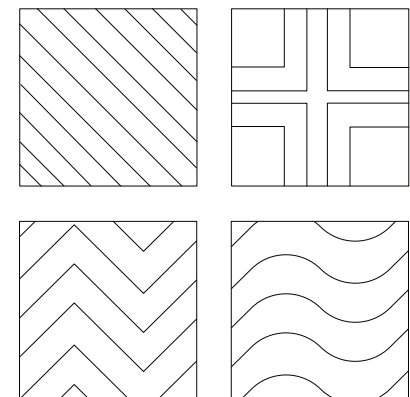

Customize your pattern



# PRODUCT SPECIFICATIONS

## STANDARD DIMENSIONS

Single Panel 23"W x 119"H

Felt Thickness  $\frac{3}{8}$ "

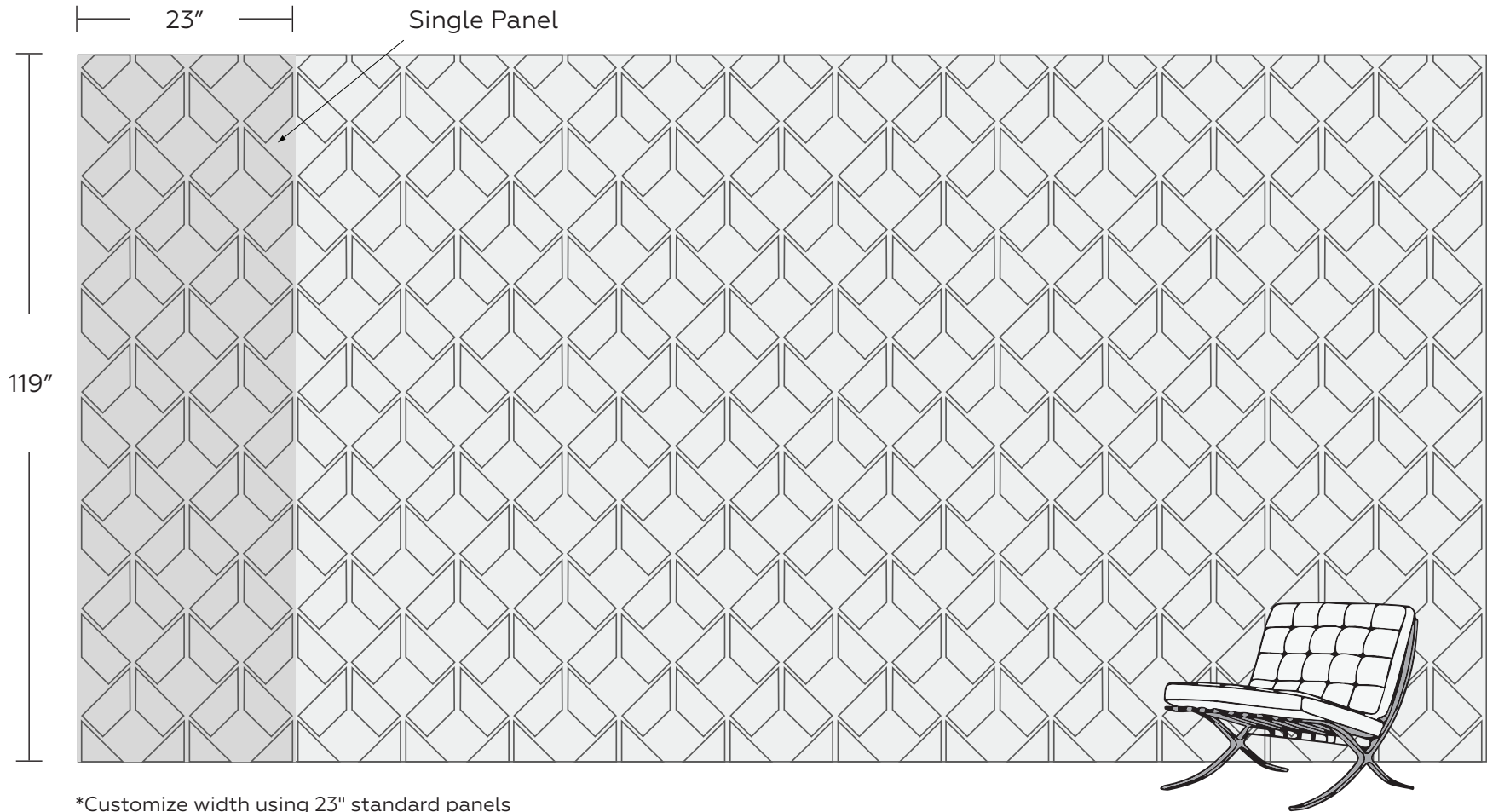



# PRODUCT SPECIFICATIONS

## PATTERN SIZES

Deco comes in three standard pattern sizes.

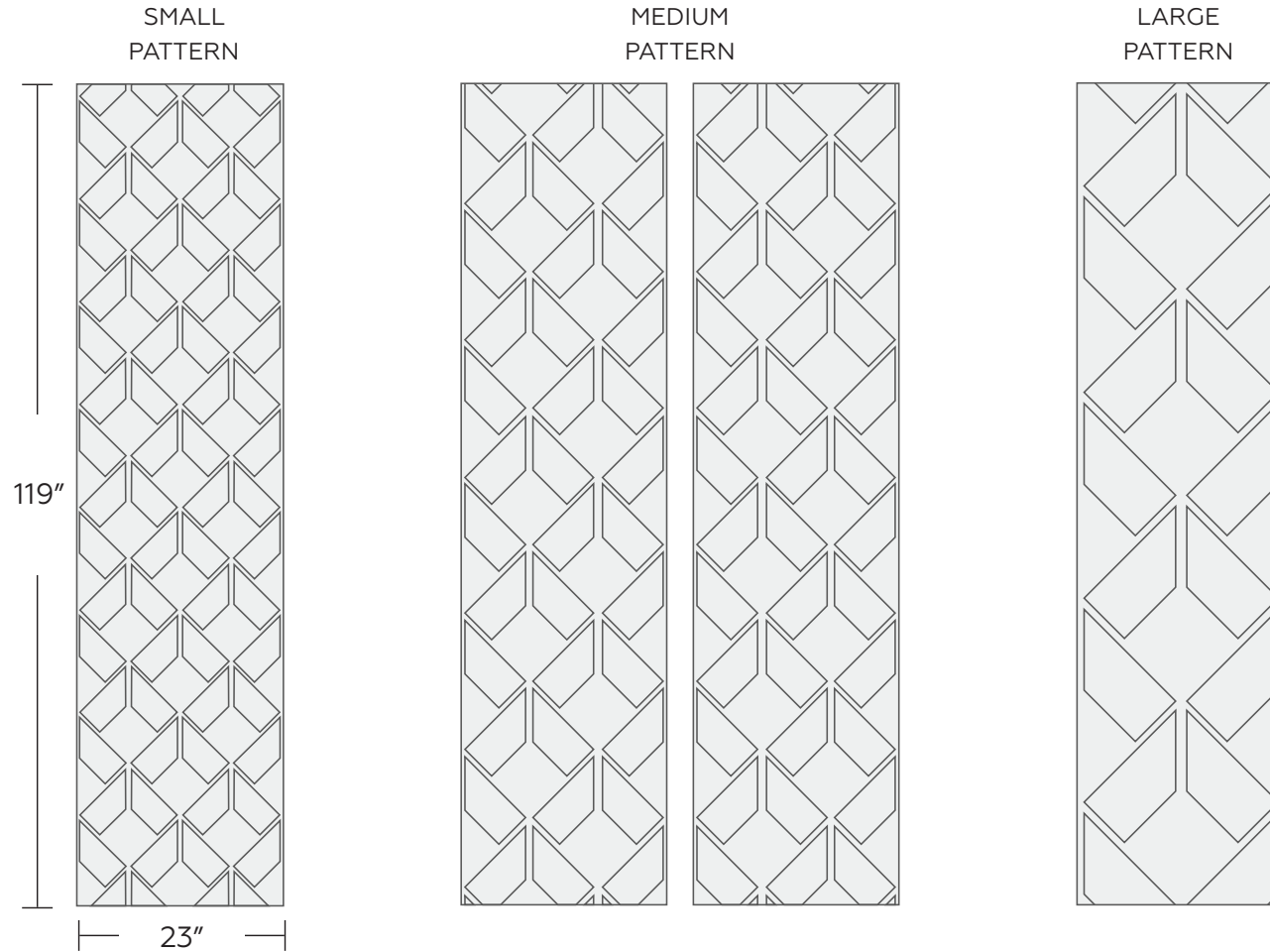



# PRODUCT SPECIFICATIONS

## CONNECTION

Standard Connection: Construction Adhesive  
(provided by MPS)

Alternate Connection: Z-Clip  
(Acoustic Enhancers Required)

## "TONGUE & GROOVE" ACOUSTIC ENHANCER

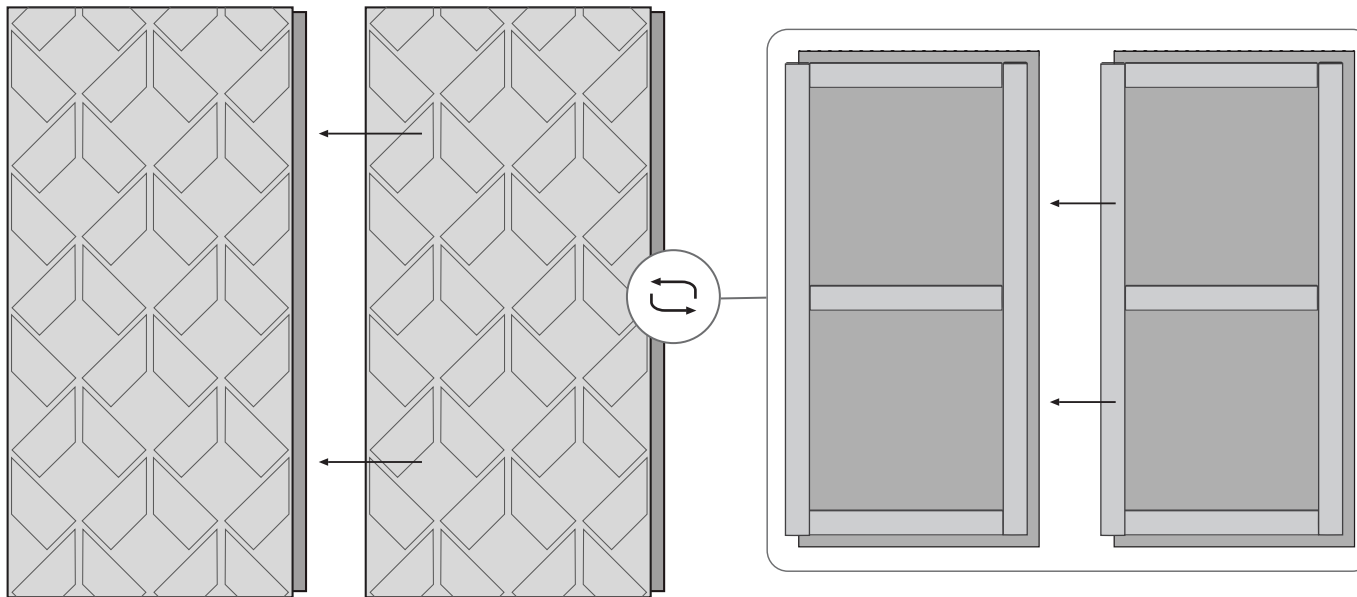



# TECHNICAL SPECIFICATIONS



## Absorption

Standard: .32 NRC

(subject to mounting conditions)

## Fire Rating

ASTM E84 Class A

## Warranty

Two (2) Years

## VOC

ASTM D5116 Compliant

## Material

PET Felt: 100% polyester fiber

## Maintenance

Vacuum clean to remove dust and debris

## Sustainability

**MPS 9mm Acoustic Panels**  
**MPS LLC**

**Final Assembly:** Trenton, Texas, USA  
**Life Expectancy:** 50 Year(s)  
**End of Life Options:** Salvageable/Reusable in its Entirety, Take Back Program (Trenton, TX), Recyclable (100%)

**Ingredients:**  
**MPS 9mm PET:** Polyethylene Terephthalate

**Living Building Challenge Criteria:** Compliant

**I-13 Red List:**  
 LBC Red List Free      % Disclosed: 100% at 100ppm  
 LBC Red List Approved      VOC Content: Not Applicable  
 Declared

**I-10 Interior Performance:** CDPH Standard Method v1.2-2017  
**I-14 Responsible Sourcing:** Not Applicable

MPS-0001  
EXP. 01 NOV 2025  
Original Issue Date: 2022

MANUFACTURER RESPONSIBLE FOR LABEL ACCURACY  
INTERNATIONAL LIVING FUTURE INSTITUTE™ [living-future.org/declare](http://living-future.org/declare)





# COLORWAYS

MPS offers a range of over 30 curated colorways.

## CURATED COLORWAYS

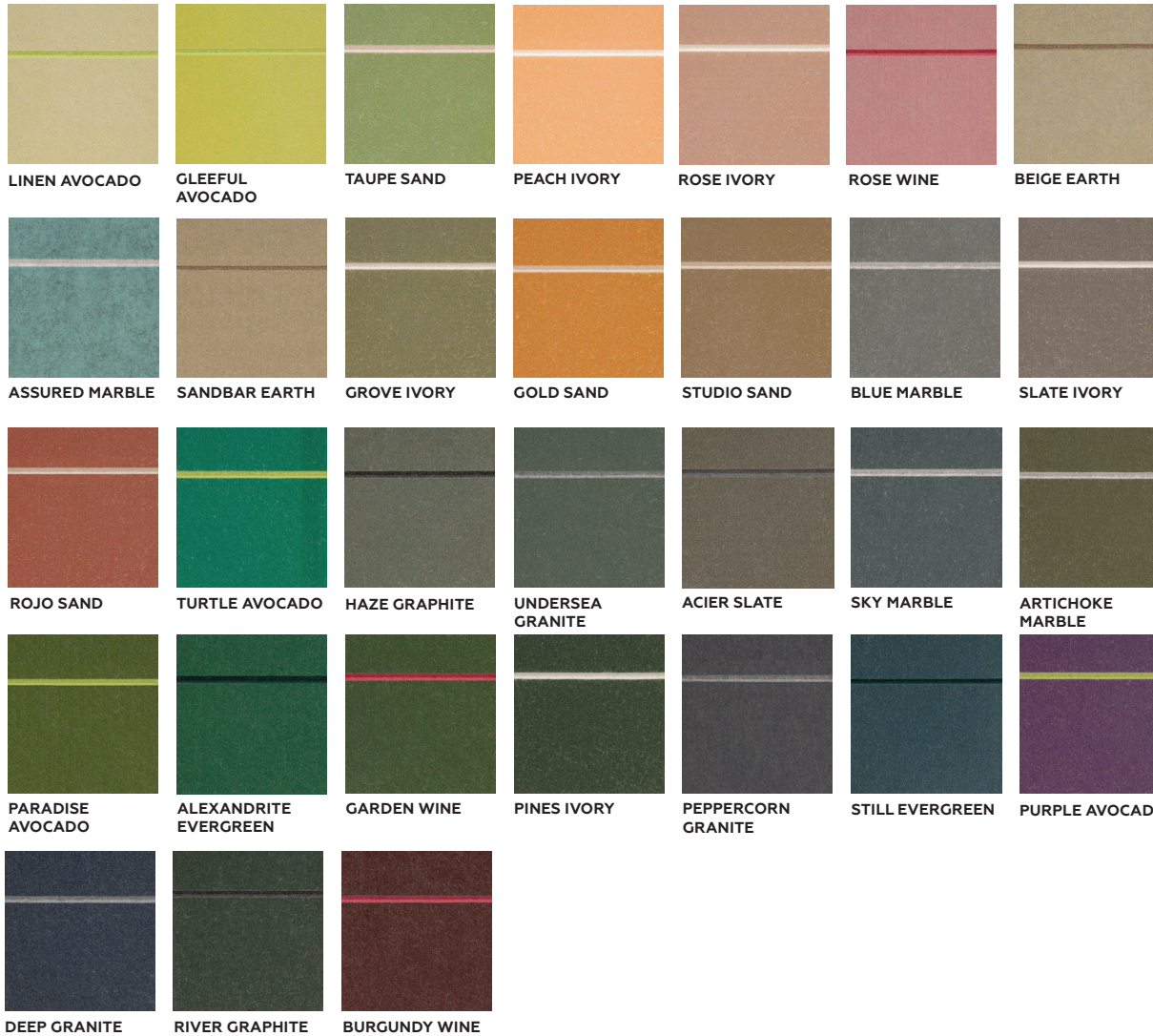

## SHADES by MPS™

Your design world revolves around color, so don't be limited by standard colors and outdated palettes. SHADES offers Pantone options, full-color prints, and unique gradients. Flat or Heathered? Your choice.

\*Some limitations apply. Consult your MPS acoustics expert to discuss your project.



# MOUNTING OPTIONS

## TOOLS REQUIRED



Cutting tool



Steel straightedge



Drill



Hole saw



Construction adhesive

## DRY FIT

Before applying adhesive, dry fit the first panel to the wall.

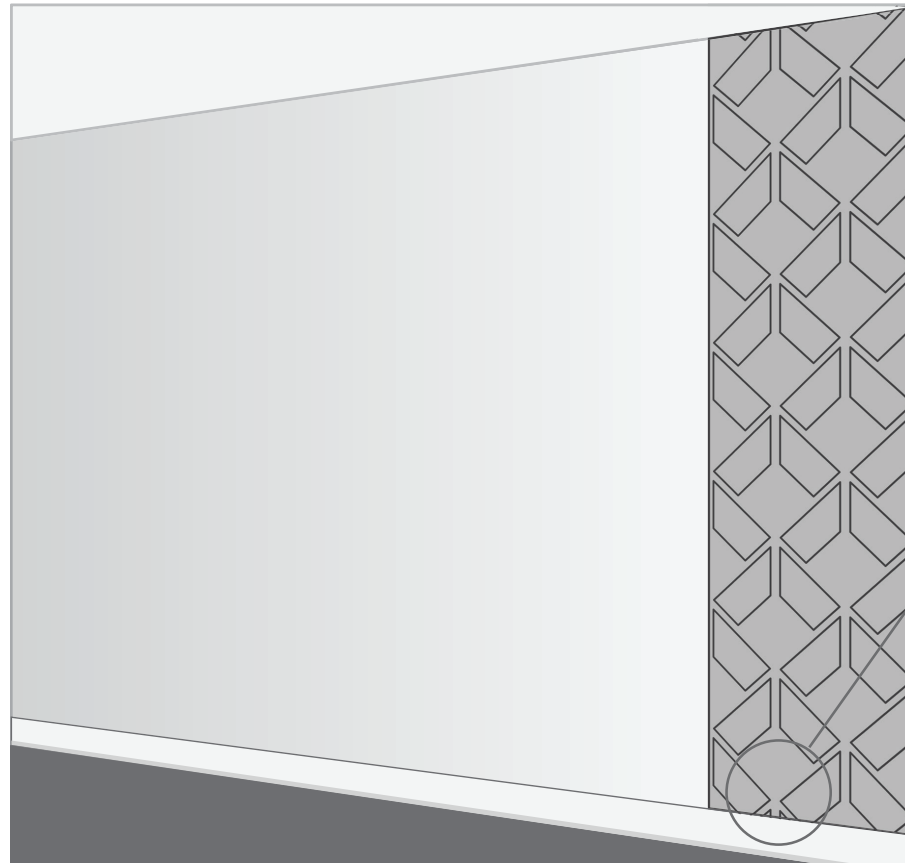

Note: to avoid irregularity, we recommend applying to the top of a baseboard.





# MOUNTING OPTIONS

## APPLY CONSTRUCTION ADHESIVE (RECOMMENDED)

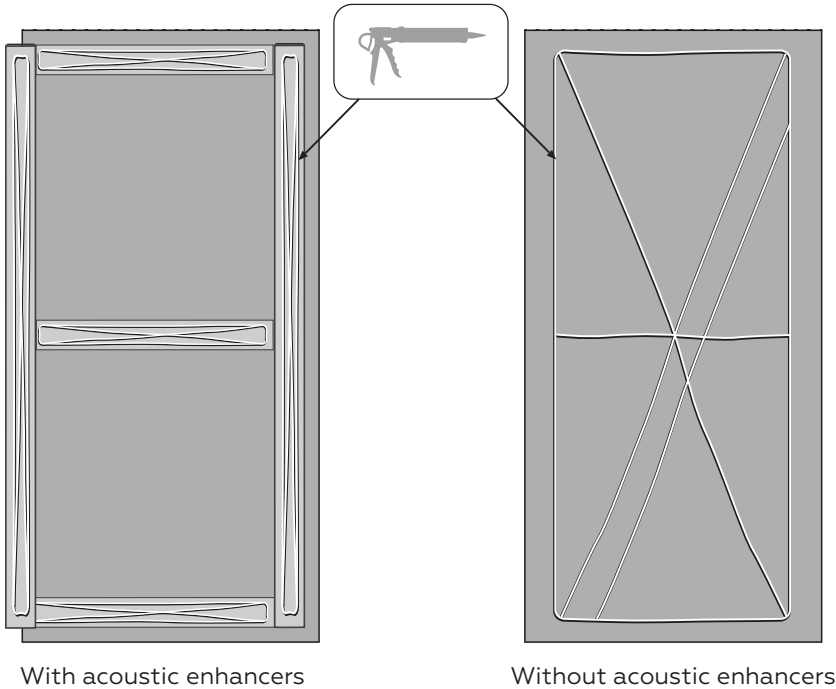

## HOOK Z-CLIPS (ALTERNATIVE)

Determine the desired position of z-clips and screw them into the back of the panel.

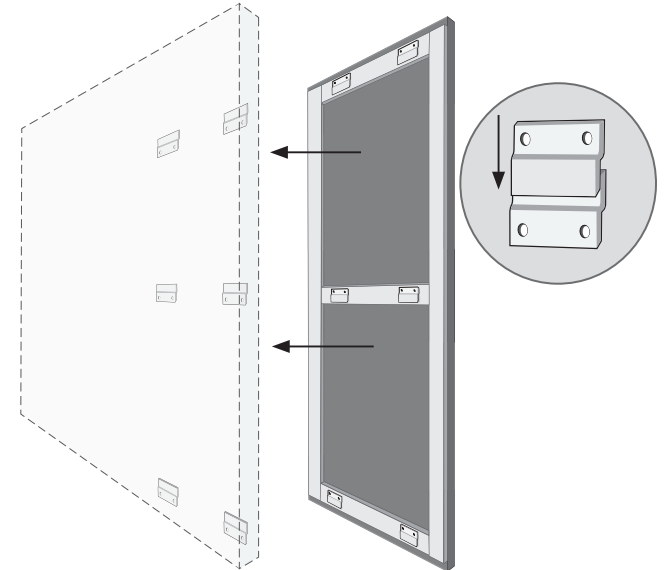

## TRIM AS REQUIRED

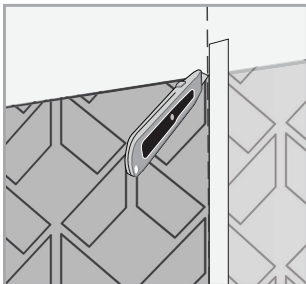

Trim panels along the end to fit using a straight edge and cutting tool.

## TRIMMING HOLES

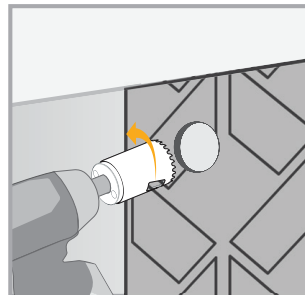

When cutting a circular hole use a hole saw, and run it backwards to minimize pulling.