



ATTACH





MINIMALIST DESIGN MEETS ACOUSTIC PERFORMANCE

These panels use magnets to help quickly reconfigure any office space, adding color, art, and visual privacy between individuals or teams.

Available in 20 standard colors as well as standard and custom dimensions.

Standard dimension:

- 92"Hx46"L

PRODUCT SPECIFICATIONS

- Easy to install - attach to metal ceiling tile grid
- Choose from 20 standard colors
- More than 20 designs
- Adds visual and acoustic privacy beautifully

Custom design and configuration options



Acoustic panel detail

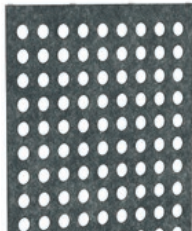

MOUNTING OPTIONS

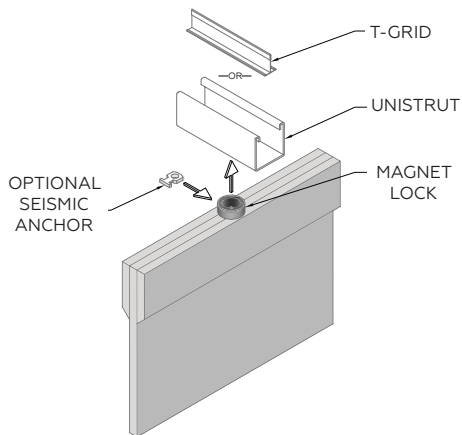

27 STANDARD PATTERNS

Customs available at no extra charge because nobody likes fees!



BANDE



BEADED



CRISTYL

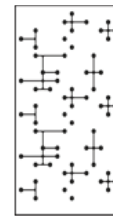

DNA



DOTS

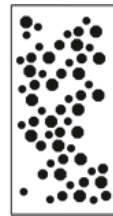

FLOAT

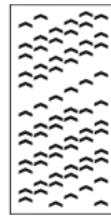

FLOCK



INKA I



INKA II



INKA III



JEAN

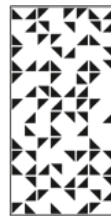

KYTE



LLAVA I



LLAVA II



LLAVA III



LUMIN II



MATRIX



MAZON I



MAZON II



MAZON III



PROFYL



RAINFALL



ROSEAU



SANTA FE



SEQUENCE



TANGRAM



ABCEED

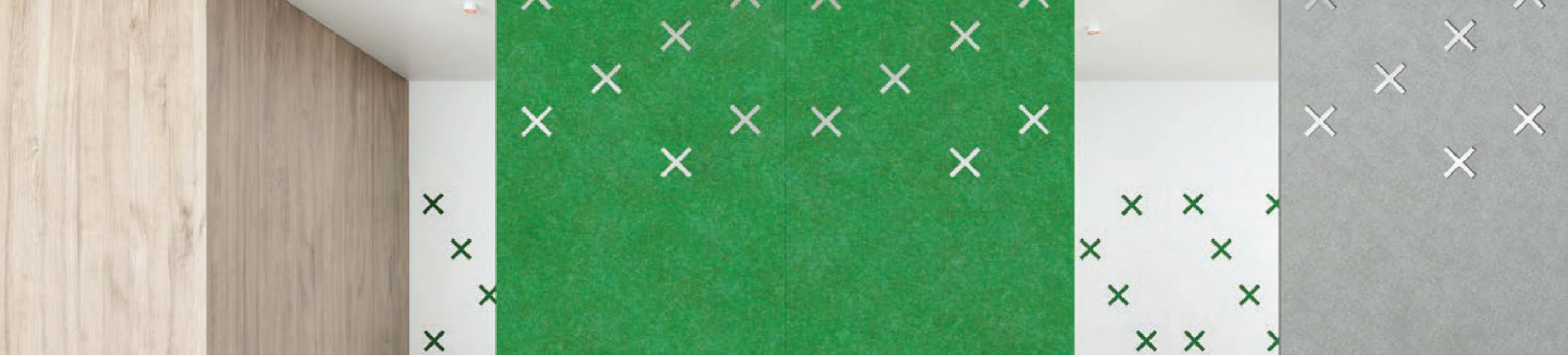

Attach comes in over 20 standard colors and 10 woodgrains.
Need something custom? Just ask.



Go ahead, design in full color.
Any shade you want.

SHADES

by

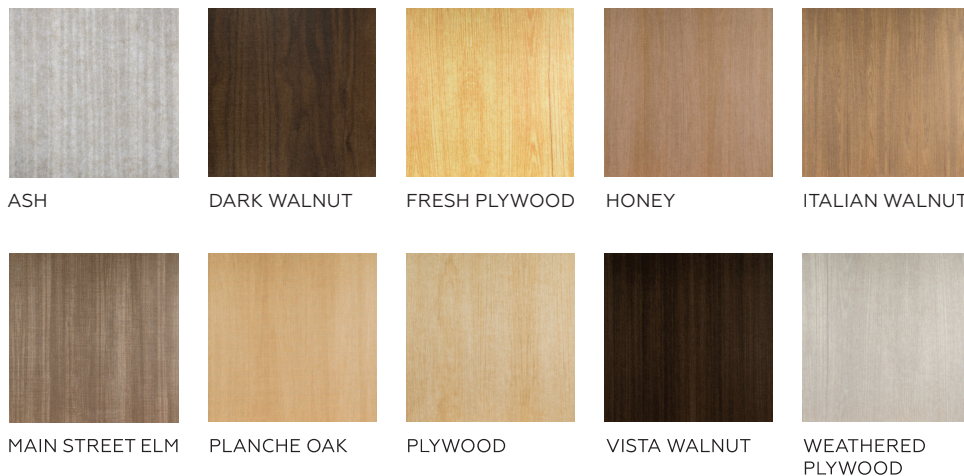

TECHNICAL SPECIFICATIONS

Absorption

Average NRC 0.85.
(subject to thickness and mounting conditions)

Material

100% polyester fiber acoustic felt.

Eco-Friendly

Yes! 60% recycled PET materials, 40% new material, non-toxic, non-allergenic, non-irritant, no coatings or sprays which degrade over time.

Fire Rating

ASTM E84 Class A Fire Spread rating is permanently achieved by infusing 40% new material into the panel. MPS never uses sprays or coatings that degrade and lose their rating status.

Sustainability

Declare.

9mm Acoustic Panels
MPS LLC

Final Assembly: Trenton, Texas, USA
Life Expectancy: 50 Year(s)
End of Life Options: Salvageable/Reusable in its Entirety, Take Back Program (Trenton, TX), Recyclable (100%)

Ingredients:
Polyethylene Terephthalate

Living Building Challenge Criteria: Compliant

I-13 Red List:
 LBC Red List Free % Disclosed: 100% at 100ppm
 LBC Red List Approved VOC Content: Not Applicable
 Declared

I-10 Interior Performance: CDPH Standard Method v1.2-2017
I-14 Responsible Sourcing: Not Applicable

MPS-0001
EXP. 01 OCT 2023
Original Issue Date: 2022

MANUFACTURER RESPONSIBLE FOR LABEL ACCURACY
INTERNATIONAL LIVING FUTURE INSTITUTE™ living-future.org/declare

