

INSTALLATION GUIDELINES CEILING BAFFLES

Baffle Installation on Different Ceiling Types

Drop Ceiling

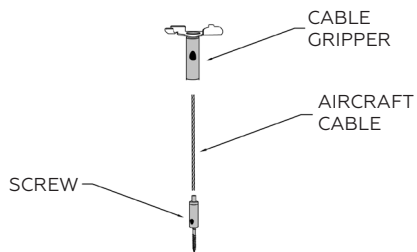

Decorative Hard Ceiling

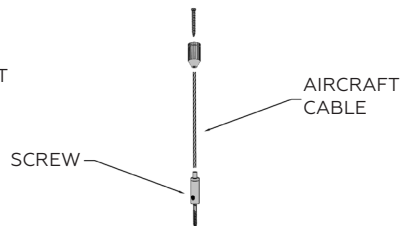

Hard Ceiling

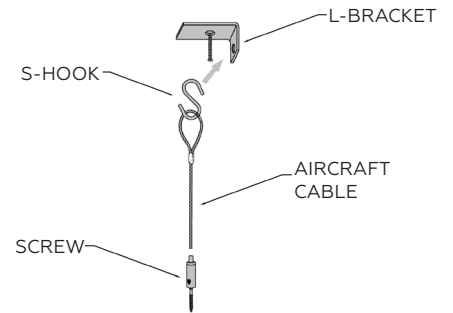

Ceiling Tile

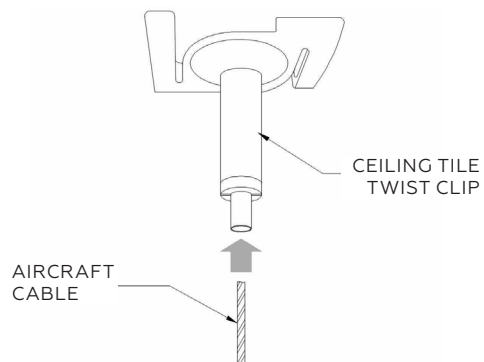

Concrete with Ramset

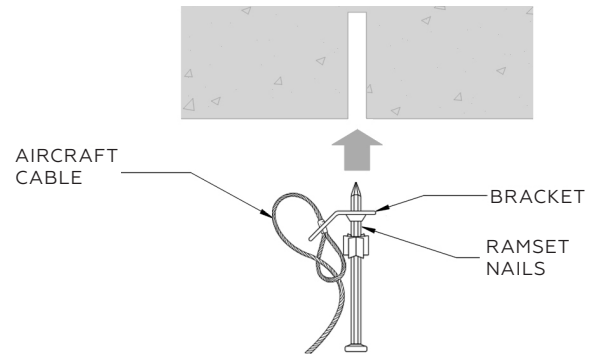

INSTALLATION

Verify that the ceiling structures are strong enough to take the weight of the baffle components being installed. All installation must be done in accordance with local building codes and with proper hardware and protective gear to ensure safety. Verify that all components are properly tightened at the end of each installation.

Tools Needed



Level

Items Included



Panels



Drywall Screws

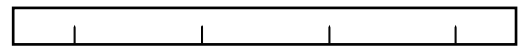

Template

INSTALLATION

1. Using a level and drywall screws, mount the template to the wall. Leave the drywall screw at least 9mm or 1/3" off the wall.

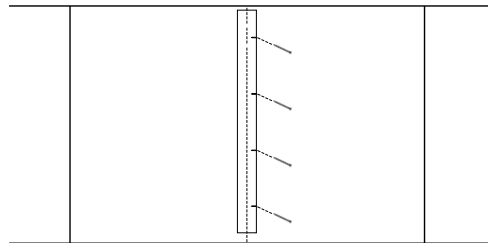

2. Remove the template (the notches should allow the template to be pulled out while leaving the drywall screws in the wall).

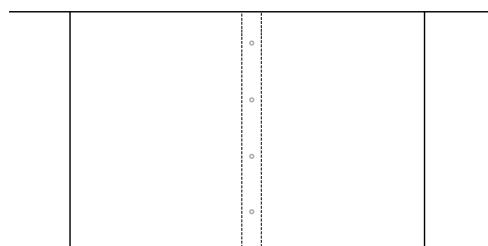

3. The now-exposed screws should slide onto the keyhole on the back of the wall components).

