

WALL-MOUNTED CONTROLLERS INSTALLATION GUIDE



VoiceArrest Sound Masking System



1 Overview

Appropriate for small projects to the biggest installations, the VoiceArrest sound masking system is simple and highly versatile, without compromise on sound masking performance and quality.

This user manual describes in details how to install the VoiceArrest controllers. The VoiceArrest controllers offer a compact form factor ideal for decentralized sound masking systems.

Table of Contents

1 Overview.....	1
2 Specifications.....	2
3 Connections.....	4
4 Installation.....	6
4.1 Safety Instructions.....	6
4.2 Securing the Controller.....	7
4.3 Powering the Controller.....	8
4.4 Connecting Loudspeakers.....	8
4.5 Connecting Active Volume Control Sensors.....	9
4.6 Connecting Volume Control Knobs.....	10
4.7 Connecting Music and Paging Sources.....	11
5 Configuration	12

2 Specifications

	VA-12-2CH	VA-24-4CH	VA-24S-4CH	VA-24S-8CH	VA-48-8CH	VA-48S-8CH
						
Can be a Project Master?	Yes	Yes	No	No	Yes	No
Outputs						
Nb Outputs	2	4	4	8	8	8
Max Nb Speakers/Outputs	6	6	6	3	6	6
Max Nb Speakers/Controller	12	24	24	24	48	48
Sound Masking						
Sound Masking Volume	30 to 88 dBA in 0.1 dB steps and mute					
Sound Masking Equalizer	Auto-calibration process in 340 narrow bands of 19 1/3 octave bands from 100Hz to 6.3kHz					
Sound Masking Ref Spectrum	13 pre-set sound masking reference spectrums, unlimited user defined spectrums					
Sound Masking Volume Ramp-Up	User defined, up to 30 days					
Active Volume Control						
Nb Sensor Inputs	2	4 (shared)	4 (shared)	8 (4shared)	8 (4shared)	8 (4shared)
Max Nb Sensors/Input	6					
Control	Independent sound masking volume adjustment for each output channel					

Specifications (Cont.)	VA-12-2CH	VA-24-4CH	VA-24S-4CH	VA-24S-8CH	VA-48-8CH	VA-48S-8CH
Masking Volume Change Rate	Adjustable down to 0.1 dB steps, updates every 15s					
Active Adjustment Range	User defined; maximum range: -7 to +3 dB relative to reference masking level					
Music and Paging						
Nb. Inputs	2	4 (shared)	4 (shared)	4 (shared)	4 (shared)	4 (shared)
Mixer	Independent for each output channel					
Volume	30 to 92 dBA in 0.1 dB steps and mute					
Equalizer	20 1/3 octave bands (125Hz to 6.3kHz)					
Volume Control Knobs						
Nb. Inputs	2					
Mixer	Independent for each output channel (Sound Masking and/or Paging and Music)					
Volume Range	User defined					
Volume Schedule						
Schedule	24 hour periods per day, 7 days					
Volume	0.1dB steps					
Transition Ramp	Instant, 2min30sec, 5min, 10min, or 15min					
Schedule Mixer	Independent for each output channel (Sound Masking and/or Paging and Music)					
Daylight Saving Time	Automatic Adjustment depending on local time zone settings					
Monitoring						
Diagnosis	Automatic					
Reporting	System diagnosis report sent by email and/or stored locally					
Requirement	Computer running Project Manager Software					
LEED						
Feature	Controller can be put in low power mode according to a daily schedule					
Schedule	7 daily periods per week (user defined)					
Connectivity						
USB	USB 2.0, Mini B connector					
Wi-Fi	802.11b/g/n, WEP 40/64-bits or WPA/WPA2 personal, 450 kbps					
Ethernet	DHCP or Static IP, 350 kbps					
Power						
Input	24 VDC					
Rating	15 W	25 W	25 W	25 W	50 W	50 W
Available Power Supply	50W, 120W and 160W (Higher power needed when powering multiple controllers)					

Specifications (Cont.)	VA-12-2CH	VA-24-4CH	VA-24S-4CH	VA-24S-8CH	VA-48-8CH	VA-48S-8CH
Physical						
Dimensions	191mm x 135mm x 28mm (7.5" x 5.3" x 1.1")			245mm x 135mm x 28mm (10" x 5.3" x 1.1")		
Weight	300g (0.7lb)			400g (0.9lb)		
Certifications						
Compliance	ETL Listed 3191772					
Safety	UL 60065 / ULC 60065					
Fire Test	UL 2043					
Electromagnetic	FCC – EN 55103-1&2					

1: A shared input can be an active volume control sensor input OR a paging/music input.

2: Wi-Fi module can be disabled if it's not required

3 Connections

VA-24S-8CH , VA-48-8CH , VA-48S-8CH

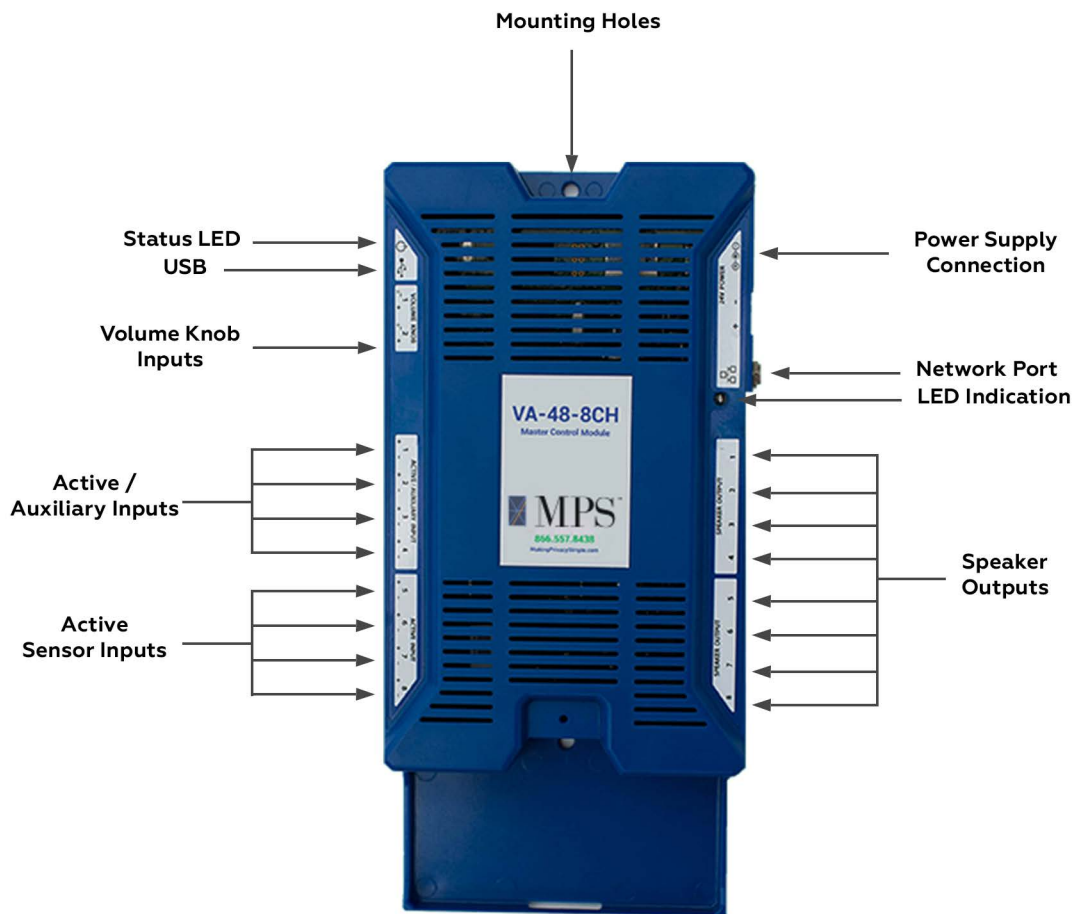

VA-24-4CH , VA-24S-4CH

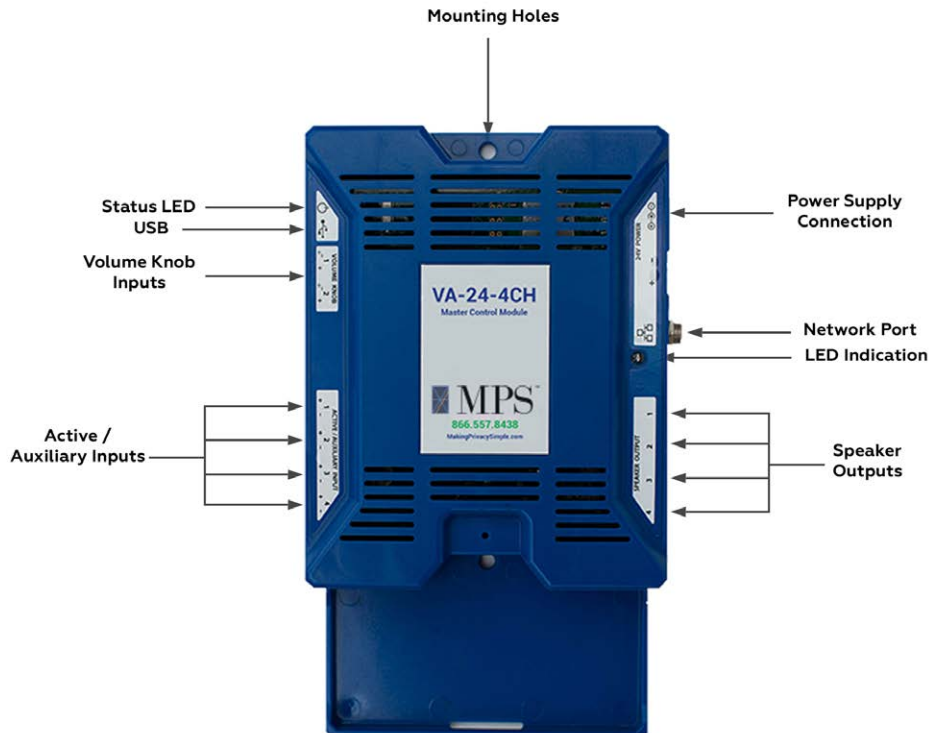

VA-12-2CH

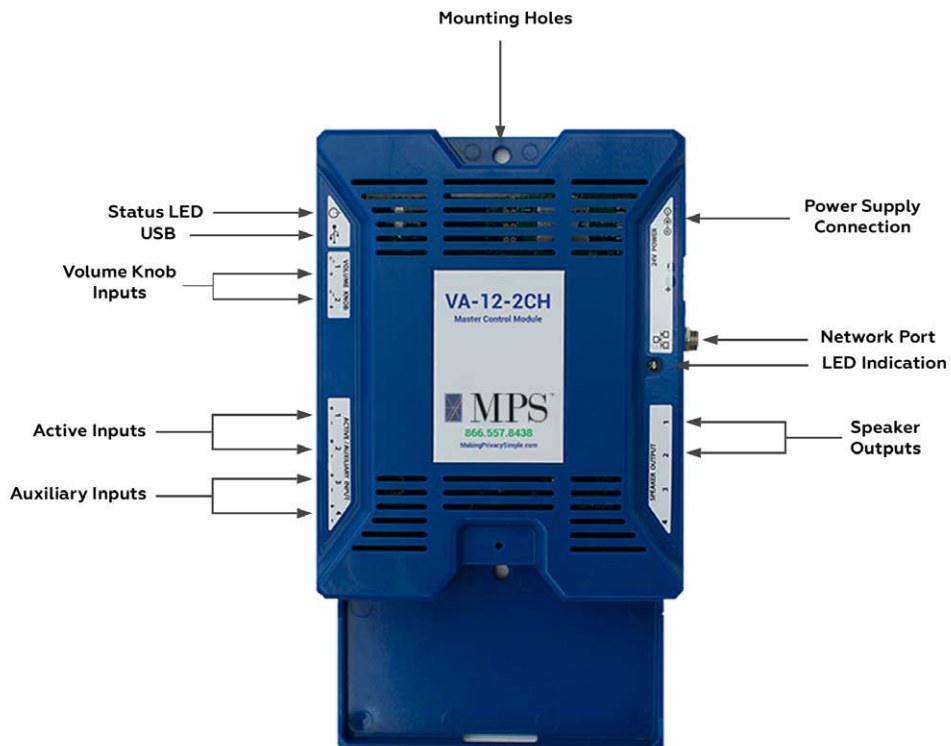

4 Installation

4.1 Safety Instructions

- Read and keep these instructions.
- Heed all warnings and follow all instructions contained within this manual.
- Install in accordance with the manufacturer's instructions.
- Clean only with dry cloth.
- Do not install near water.
- Do not block any ventilation openings.
- Do not install near any heat sources such as radiators, heat registers, stoves, or other apparatus (including amplifiers) that produce heat.
- Use the power cord with sealed mains plug appropriate for your local main supply as provided with the equipment. If the provided plug does not fit into you outlet contact the manufacturer.
- Protect the power cord from being walked on or pinched particularly at plugs, convenience receptacles, and the point where they exit from the apparatus.
- Only use attachments and accessories specified by the manufacturer.
- Refer all servicing to qualified service personnel. Servicing is required when the apparatus has been damaged in any way, such as when the power-supply cord or plug is damaged, liquid has been spilled or objects have fallen into the apparatus, the apparatus has been exposed to rain or moisture, does not operate normally, or has been dropped.
- Operate the product only with the voltage specified on the unit. Fire and/or electric shock may result if a higher voltage is used.
- Do not modify, kink, or cut the power cord. Do not place the power cord in close proximity to heaters and do not place heavy objects on the power cord and/or the product itself, doing so may result in fire or electrical shock.
- Be sure the installation of this product is stable, avoid slanted surfaces as the product may fall and cause injury, property damage, electrocution and/or fire.
- Do not open the cover.

4.2 Securing the Controller

The VoiceArrest controllers with a plenum-mount form factor are designed to be installed in the plenum space close to the loudspeaker. These plenum-mount controllers are equipped with two mounting holes to fasten them directly to the building structure.

You can also attach these units to a M350 DIN Rail using commonly available mounting brackets.



A rack-mount shelf can also be used to install the plenum-mount controllers in a rack-mount cabinet. Simply attach DIN-Rails at the bottom of the shelf.



Note: A minimum space of 2U is required using this configuration.

4.3 Powering the Controller

The plenum-mount controllers are powered using a 50W power-supply (EA1050, sold separately). Connect the barrel connector from the power-supply to the corresponding connector on the controller.

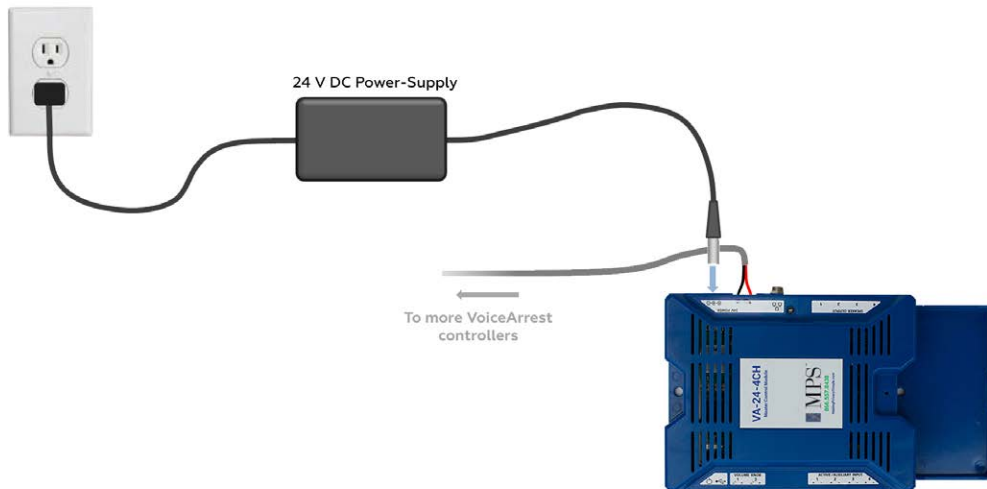

4.4 Connecting Loudspeakers

Sound masking loudspeakers are typically suspended from the deck, above the acoustic ceiling tiles. Different types of loudspeaker can be used depending on the installation requirement. Refer to the loudspeaker user guide for more information.

Use 18-AWG 2-Conductors wire to connect the loudspeakers to the VoiceArrest controller. Use plenum rated cable and follow local regulations. Typical wire will be 18/2 FT4. All speakers on a channel are connected in parallel using twist-on connectors.

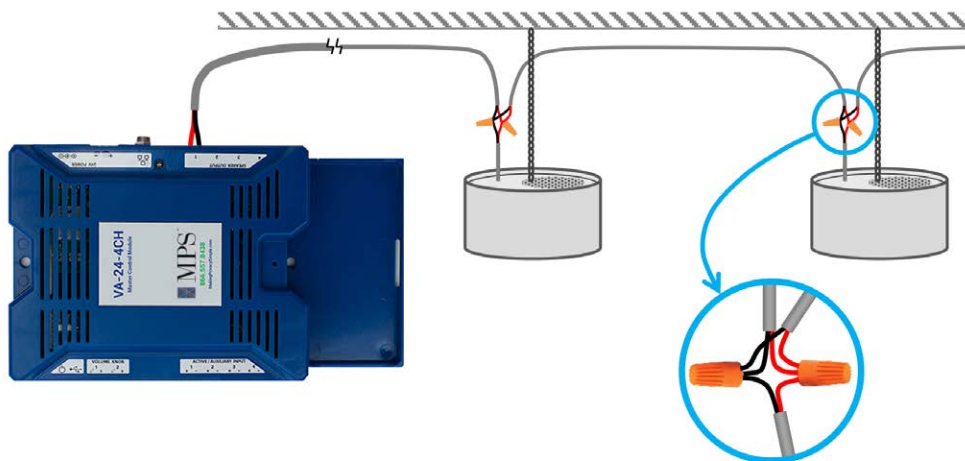

Refer to the table below for speaker load specifications.

Speaker Load Specifications for VA-48-8CH, VA-48S-8CH, VA-24-4CH, VA-24S-4CH, VA-12-2CH

Speaker Model	VA-SPK	VA-DIRECT	VA-SURF4	VA-FLAT	VA-HDN	VA-VIBX
Max. Nb. Speakers per Output	6	6	6	6	4	4
Tap Setting	0dB (4W)	4W	4W	4W	0dB	---

Refer to the table below for speaker load specifications.

Speaker Load Specifications for VA-24S-8CH

Speaker Model	VA-SPK	VA-DIRECT	VA-SURF4	VA-FLAT	VA-HDN	VA-VIBX
Max. Nb. Speakers per Output	3	3	3	3	3	3
Tap Setting	0dB (4W)	4W	4W	4W	0dB	---

4.5 Connecting Active Volume Control Sensors

The best location to put the active sound masking volume control sensor is through the acoustic tile. Sensors must be installed, if possible, in a central position to catch most of the noise in the zone.



Connect the sensor with 22 AWG shielded cable and BCN connectors. Up to 6 sensors can be connected on the active input. Connect the shield wire on the negative terminal on the controller end only, do not connect the shield on the sensor terminal and let it float. If many sensors are used, connect the shield between them to ensure continuity.

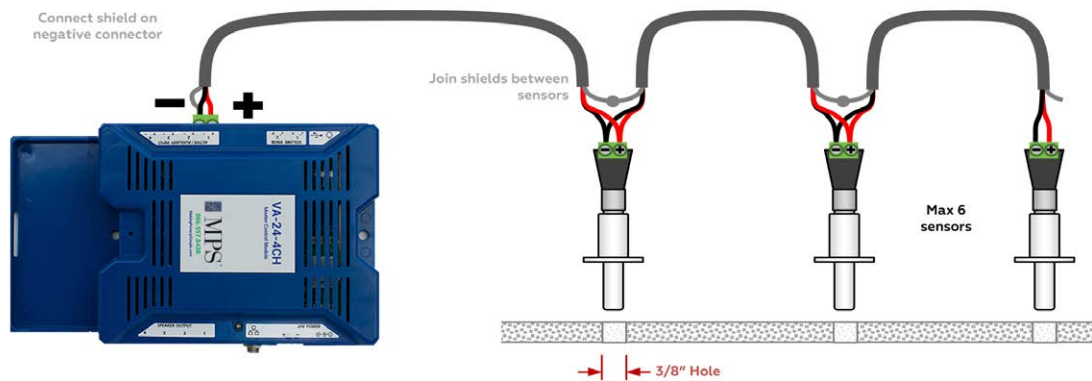

Note: When a long cable is used, it's recommended to run the cable separate from the speaker lines. A minimal distance of 12 inches between the speaker wires and the volume control cable is recommended.

Refer to the Active Control Sensor User Guide for more information on Active Control. Refer to the Design Guidelines Handbook for more information on sensor layout.

4.6 Connecting Volume Control Knobs

Up to two volume control knobs can be connected to control the sound masking volume and/or the music and paging volume. Use the VA-RC for this application.



VA-RC Zone Volume Control Knob

Use 22 AWG shielded cable to connect the volume controls. Connect the "CTRL" connector to the red wire and the "COM" connector to the black wire. Connect the red wire to the "+" connector on the controller and the black wire on the "-" connector. Connect the shield on the "-" connector on the VoiceArrest controller side and leave it disconnected on the volume control side.

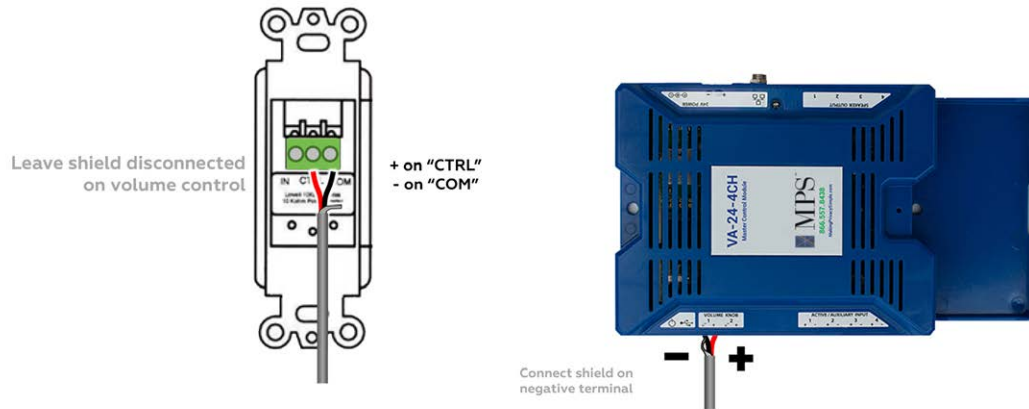

Note: When a long cable is used, it's recommended to run the cable separate from the speaker lines. A minimal distance on 12 inches between the speaker wires and the volume control cable is recommended.

The volume control input can also be used to turn OFF sound masking and music during a fire alarm. For more information, refer to the Application Note on "How to mute sound masking during a fire alarm".

For some applications, it's useful to have a volume knob directly on the speaker line. For more information, refer to the VA-RC speaker volume control.

4.7 Connecting Music and Paging Sources

The auxiliary inputs can be used to connect any line-level music or paging source to the system. The auxiliary input range is ± 2 V. Only mono channel sources can be connected (no stereo).

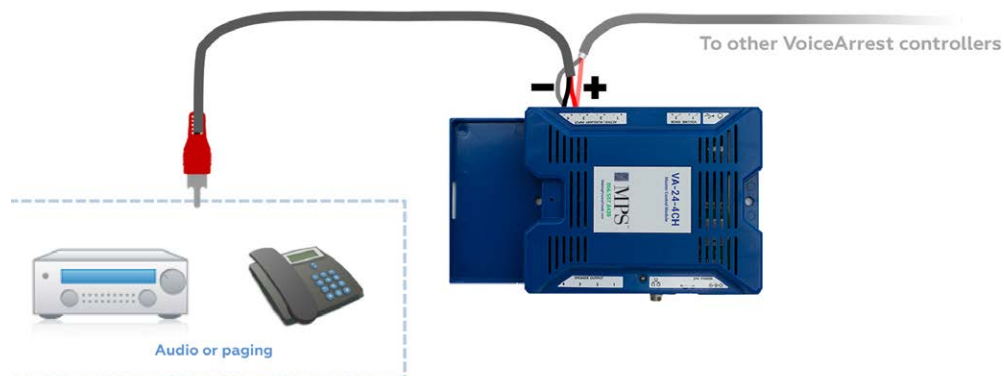

It is recommended to use the auxiliary input 1 for paging as this input features a trigger allowing to lower the volume of masking and music during the public announcement. Refer to the Project Manager User Guide for more information.

Use shielded cable when distributing the auxiliary signal to additional VoiceArrest controllers. It's recommended to connect the shield to the ground terminal to lower any noise.

When powering multiple units from the same source, ensure that the source is strong enough. Otherwise, use a preamp to increase the signal strength. As an example, an iPod can drive up to 3 VoiceArrest controllers directly but requires a preamp when driving more than 3 units. Additionally, ground loops and other problems can arise when connecting multiple controller units together. To avoid these problems, a small isolation transformer is available. Refer to the Application Note on the AUX-ISO isolation transformer for more information.

When telephone paging is required, it is recommended to use a telephone interface such as the BOGEN UTI312. Refer to the Application Note on "Using the Bogen UTI-312 as a paging source for more information" .

5 Configuration

The controllers are configured using the VoiceArrest Project Manager software. The Project Manager software communicates with the controllers using either:

- USB,
- Wi-Fi,
- or Ethernet.

All these communication interfaces can be used transparently on the same project meaning that VoiceArrest controllers can be connected using USB, Wi-Fi or Ethernet without limitation.

Note that communication is required to change system parameters but is not required for normal operation unless an end-user control panel or system monitoring is required.

Refer to the VoiceArrest Project Manager User Guide for more information.